

COLORBLAZE 48, COLORBLAZE 72

USER GUIDE



COLOR KINETICS INCORPORATED
10 MILK STREET, SUITE 1100
BOSTON, MA 02108 USA
TEL 888 FULL RGB
TEL 617 423 9999
FAX 617 423 9998
INFO@COLORKINETICS.COM
WWW.COLORKINETICS.COM

CHROMACORE[®]
BY COLOR KINETICS

OPTIBIN[®]
BY COLOR KINETICS

ITEM# 116-000015-00 (ColorBlaze 72, Black)
116-000015-01 (ColorBlaze 72, White)
116-000016-00 (ColorBlaze 48, Black)
116-000016-01 (ColorBlaze 48, White)

This product is protected by one or more of the following patents: U.S. Patent Nos. 6,016,038, 6,150,774 and other patents listed at <http://colorkinetics.com/patents/>. Other patents pending.

©2003-2006 Color Kinetics Incorporated. All rights reserved. Chromacore, Chromasic, Color Kinetics, the Color Kinetics logo, ColorBlast, ColorBlaze, ColorBurst, ColorCast, ColorPlay, ColorScope, Direct Light, iColor, iColor Cove, iPlayer, Optibin, Powercore, QuickPlay, Sauce, the Sauce logo, and Smartjuice are registered trademarks and DMand, EssentialWhite, eV, IntelliWhite, iW, and Light Without Limits are trademarks of Color Kinetics Incorporated.

PUB-000144-00 Rev. 02

Specifications subject to change without notice.



Scope of This User Guide

The goal of this user guide is to explain in easily understood language the necessary steps to install ColorBlaze and assure peak performance. Its intended use is for reference only, by fully qualified professionals. This document should never be considered a substitute for any provisions of a regulation or state and/or local code.

Identification and Warnings of Safety Hazards

In accordance with ANSI Z535.4-2002 the following system of identifying the severity of the hazards associated with the products is used:

“**WARNING**” Potentially hazardous situation which, if not avoided, could result in death or serious injury.

“**CAUTION**” Potentially hazardous situation which, if not avoided, may result in minor or moderate injury or property damage. Also used to alert against unsafe practices.

IGNORING A HAZARD WILL VOID ANY WARRANTY.

WARNING: The ColorBlaze power plug must be installed by a qualified professional in accordance with NEC and relevant local codes.

WARNING: Do not attempt to install or use ColorBlaze until you read and understand the installation instructions and safety labels.

WARNING: As dictated by a Structural Engineer and/or local code, install safety cables to ColorBlaze fixtures.

WARNING: When using safety cables, ensure that they comply to the local specifications or the example provided in this user guide.

WARNING: Do not use ColorBlaze if the power cable is damaged. Damaged cables must be replaced by the manufacturer, service agent(s), or a similar qualified person.

CAUTION: ColorBlaze is an indoor only rated product, do not operate outdoors.

CAUTION: Use ColorBlaze in a ventilated area with at least 3 inches of open air on all sides.

CAUTION: ColorBlaze has no serviceable parts. Do not attempt to open the fixture.

CAUTION: Do not use sharp tools near or on the fixture lens.

NOTE: The instructions and precautions set forth in this user guide are not necessarily all-inclusive, all conceivable, or relevant to all applications as Color Kinetics cannot anticipate all conceivable or unique situations.

Owner/User Responsibilities

It is the responsibility of the contractor, installer, purchaser, owner, and user to install, maintain, and operate ColorBlaze in such a manner as to comply with all state and local laws, ordinances, regulations, and the American Standard Institution Safety Code.

PREPARING COLORBLAZE FOR USE

1. Install the power plug.
2. Connect power.
3. Address the light segments.
4. Connect data.
5. Mount and aim the fixture.

Installing the Power Plug

The on-board, auto-switching power supplies automatically adjusts to any 50 - 60 Hz AC power source from 110 to 240 volts. Install a 2-pole, 3-wire, grounded, 15A plug to the power cable. Consult a qualified electrician if in doubt about proper plug installation.

Following the plug manufacturer’s instructions, connect the green and yellow wire to ground (earth), the black wire to live, and the white wire to neutral.

Wire (US)	Pin	Marking
Black	Line	"L"
White	Neutral	"N"
Green/Yellow	Ground	

Connecting Power

WARNING: If you use a cable other than the supplied US UL rated IEC power cable, consult your local distributor to obtain a cable of equivalent size and rating and that meets local standards. Also, the locking mechanism on the IEC Inlet is for a C13 plug. Ensure that the plug on your power cable can be held securely in place in the IEC Inlet. Failure to do so could result in death or serious injury and will void the warranty.

1. Connect the IEC power cable to IEC Inlet on the back of the ColorBlaze fixture.
2. Tighten the screw on the IEC Inlet to hold the power cable in place.

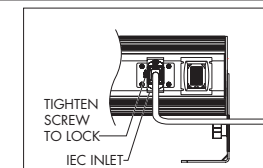

Addressing the Light Segments

IMPORTANT: Before addressing ColorBlaze, you must connect the IEC power cable, the power plug, and supply power to the fixture.

ColorBlaze uses direct DMX data and features on-board addressing tools.

Things to Consider:

Before addressing ColorBlaze, consider the following:

- The number of desired DMX addresses (address groups) per fixture.
- Each light group uses three DMX channels (RGB).
- The DMX Start Channel for the fixture. The defined light groups auto-address sequentially beginning with the DMX Start Channel. To use multiple ColorBlaze fixtures in a sequential application, it is necessary to calculate the last channel used on the previous fixture to determine the DMX Start Channel for the next fixture.

Setting the Address Groups

The first step in addressing the fixture is to set the number of groups. Using the “NUMBER OF GROUPS” selection button, press + or - to scroll to the number of groups for the fixture. Refer to the table below.

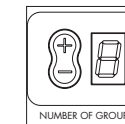

ColorBlaze 48

1 = All segments set to the same DMX address

GROUP 1			
001			

2 = Two DMX addresses set to two groups of four segments

GROUP 1		GROUP 2	
001		004	

4 = Four DMX addresses set to four groups of two segments

GROUP 1	GROUP 2	GROUP 3	GROUP 4
001	004	007	010

A = Eight individual DMX addresses

GROUP 1	GROUP 2	GROUP 3	GROUP 4	GROUP 5	GROUP 6	GRP 7	GRP 8
001	004	007	010	013	016	019	022

ColorBlaze 72

1 = All segments set to the same DMX address

GROUP 1			
001			

2 = Two DMX addresses set to two groups of six segments

GROUP 1		GROUP 2	
001		004	

3 = Three DMX addresses set to three groups of four segments

GROUP 1	GROUP 2	GROUP 3
001	004	007

4 = Four DMX addresses set to four groups of three segments

GROUP 1	GROUP 2	GROUP 3	GROUP 4
001	004	007	010

6 = Six DMX addresses set to six groups of two segments

GROUP 1	GROUP 2	GROUP 3	GROUP 4	GROUP 5	GROUP 6
001	004	007	010	013	016

A = Twelve individual DMX addresses

GRP 1	GRP 2	GRP 3	GRP 4	GRP 5	GRP 6	GRP 7	GRP 8	GRP 9	GRP 10	GRP 11	GRP 12
001	004	007	010	013	016	019	022	025	028	031	034

*Examples assume start channel is 001 with three DMX channels per group.

Setting the DMX Start Channel

After setting the number of groups, set the DMX start channel. Using the “DMX START CHANNEL” selection button, press + or - to enter the DMX channel for the first, or only, light group in fixture. All other groups auto-address sequentially beginning with the DMX address entered. See DMX table at www.colorkinetics.com/support/datasheets/dmx.pdf.

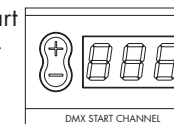

Example (ColorBlaze 72): “NUMBER OF GROUPS” set to 3, “DMX START CHANNEL” set to 007: The first four light segments (first group) is set to 007, the next four light segments (second group) set to 010, and the last four light segments (third group) set to 013.

Testing the Lights

After addressing the segments, press and hold the test button.

Each light segment flashes white sequentially to verify that each segment is receiving power and data, that the control boards are functioning, and that the LEDs are operational.



Connecting Data

Using an RJ45 or XLR-5 data cable, connect data directly from a DMX controller to the DMX DATA IN ports on the back of ColorBlaze. Data can be daisy chained to multiple fixtures by connecting the DMX DATA OUT port to the DMX DATA IN port of the next fixture using an RJ45 or XLR-5 data cable.

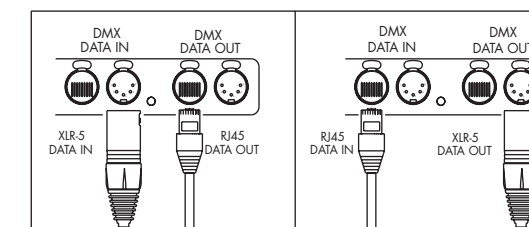
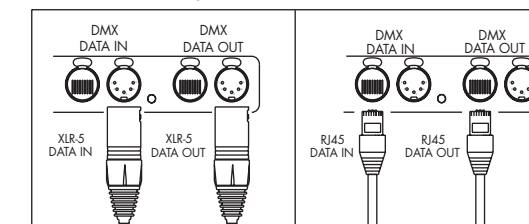

Things to remember:

- DMX data chains do not need to be connector specific. For example: XLR-5 input with RJ45 output and vice versa.
- Maximum DMX data run from DMX source to last fixture in chain is 1000 feet (300 m).
- Place a data terminator in the DMX data port of the last fixture in a chain.

Mounting and Aiming the Fixture

The ColorBlaze mounting brackets are designed for 1/2” mounting hardware and for use with pipe clamps and Cheeseborough clamps.

Mount the fixture as dictated by local or state code. Attach safety cables in suspended installations, or as required. Consult a Structural Engineer or safety professional to ensure proper mounting.

Attaching the Safety Cables

If appropriate, loop the safety cable(s) through the restraining hole(s) located at the end(s) of the ColorBlaze housing as shown. Securely anchor safety cable(s) according to local and/or state codes.

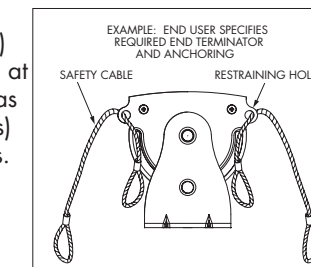

The number and location of cables required for your installation should be determined by a Structural Engineer or safety professional.

The safety cables used in the installation shall meet the following minimal requirements:

MATERIAL AND DIMENSION: Determined by installer and/or owner.

BREAK LOAD: The minimum break load for the cable and all cable anchoring construction is 600 pounds, total, minimum break strength.

CONSTRUCTION: 7 x 7 (49 wires) pre-formed stranded.

END TERMINATOR: Determined by installer and/or owner.

MOUNTING METHOD: Determined by installer and/or owner.

WARNING: To prevent mounting failure, ensure end cap screws are in place and tight, ensure mounting hardware is properly attached and tight, and use safety tether cables. Failure to do so could result in death or serious injury.

Aiming the Fixture

Loosen the locking knobs located at each end of the ColorBlaze. The fixture will rotate freely. Rotate the fixture to desired position then tighten the locking knobs. An M10 Hex key can be used to securely lock the position in high vibration environments, although generally the locking knobs only require hand tightening.

USING COLORPLAY WITH COLORBLAZE

ColorPlay® is an excellent tool for creating light shows for ColorBlaze. To create such a show, the light must be properly mapped. After setting the “Number of Groups” and the DMX Channels for the ColorBlaze fixture, you are ready to map the light.

1. From the **LIGHT PALETTE**, click a light icon then drag and drop it into the **MAPPING GRID**.
2. Double click the icon. The **LIGHT PROPERTIES** dialog box appears. Using the radial button, select **DMX CHANNEL NUMBER**. Set the DMX start channel for the fixture. Click **OK**.

3. Continue dragging icons to the mapping screen—one for each group on the fixture.

ColorPlay will automatically assign the next available light number, comprising three DMX channels, to each mapped light icon.

4. After mapping the ColorBlaze lights, continue creating light shows using the **TIMELINE EDITOR**, then download the show using the **DOWNLOAD** screen.

Refer to the ColorPlay User Guide for complete instructions and tutorials for creating light shows.

A DMX addressing table is located at www.colorkinetics.com/support/datasheets/dmx.pdf.

NOTE: Exercise caution when using the Group command in ColorPlay. Creating groups in ColorPlay can override groups settings on the ColorBlaze fixture.

CLEANING COLORBLAZE

To protect the clear polycarbonate lens, use caution when cleaning ColorBlaze. Use water and a mild detergent with a soft cleaning cloth to wipe the fixture clean.

CAUTION: Do not use paper towels, abrasive cleaning products, or window cleaners. Abrasive cleaning products will scratch the lens, and window cleaners will soften the polycarbonate allowing even soft paper towels to mar the finish. Doing so may result in minor or moderate injury or property damage and will void the warranty.

CAUTION: Do not use solvents, such as ammonia or isopropyl alcohol on the lens. Such solvents can result in scratching, pitting, hazing, yellowing, or cracking of the lens. Doing so may result in minor or moderate injury or property damage and will void the warranty.

Clean ColorBlaze housing regularly.

CAUTION: To prevent overheating, ensure that ColorBlaze housing heat fins are free of debris and heavy dust. Failure to do so may result in minor or moderate injury or property damage and will void the warranty.

CLEANING THE AIR INTAKE FILTER

To prevent overheating, inspect the air intake filter frequently and clean as needed. The air intake filters are located near each end, on the back of the ColorBlaze fixture.

WARNING: Do not operate ColorBlaze without the air intake filter in place. Doing so could result in death or serious injury and will void the warranty.

CAUTION: To prevent overheating, ensure that ColorBlaze housing heat fins are free of debris and heavy dust. Failure to do so may result in minor or moderate injury or property damage and will void the warranty.

1. Disconnect power. Never attempt to service ColorBlaze with the power connected.
2. Rotate ColorBlaze to access the air intake filters.
3. Remove the four screws which hold the filter in place.
4. Using the tab, lift the filter to remove it.
Exercise caution to prevent the washers or screws from falling into the housing opening.
5. Using water, clean the filter then completely dry.
6. Replace the filter, ensuring that gasket and washers are in place.

WARNING: Disconnect power before removing air intake filters. Failure to do so could result in death or serious injury and will void the warranty.

CAUTION: Capacitors in ColorBlaze can hold a charge after power is disconnected. Do not insert anything into filter opening. Doing so can result in minor or moderate injury or property damage and will void the warranty.

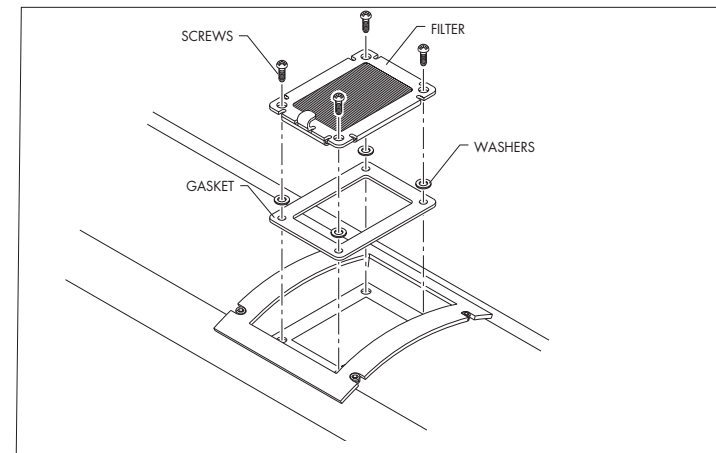

Wiring Diagram

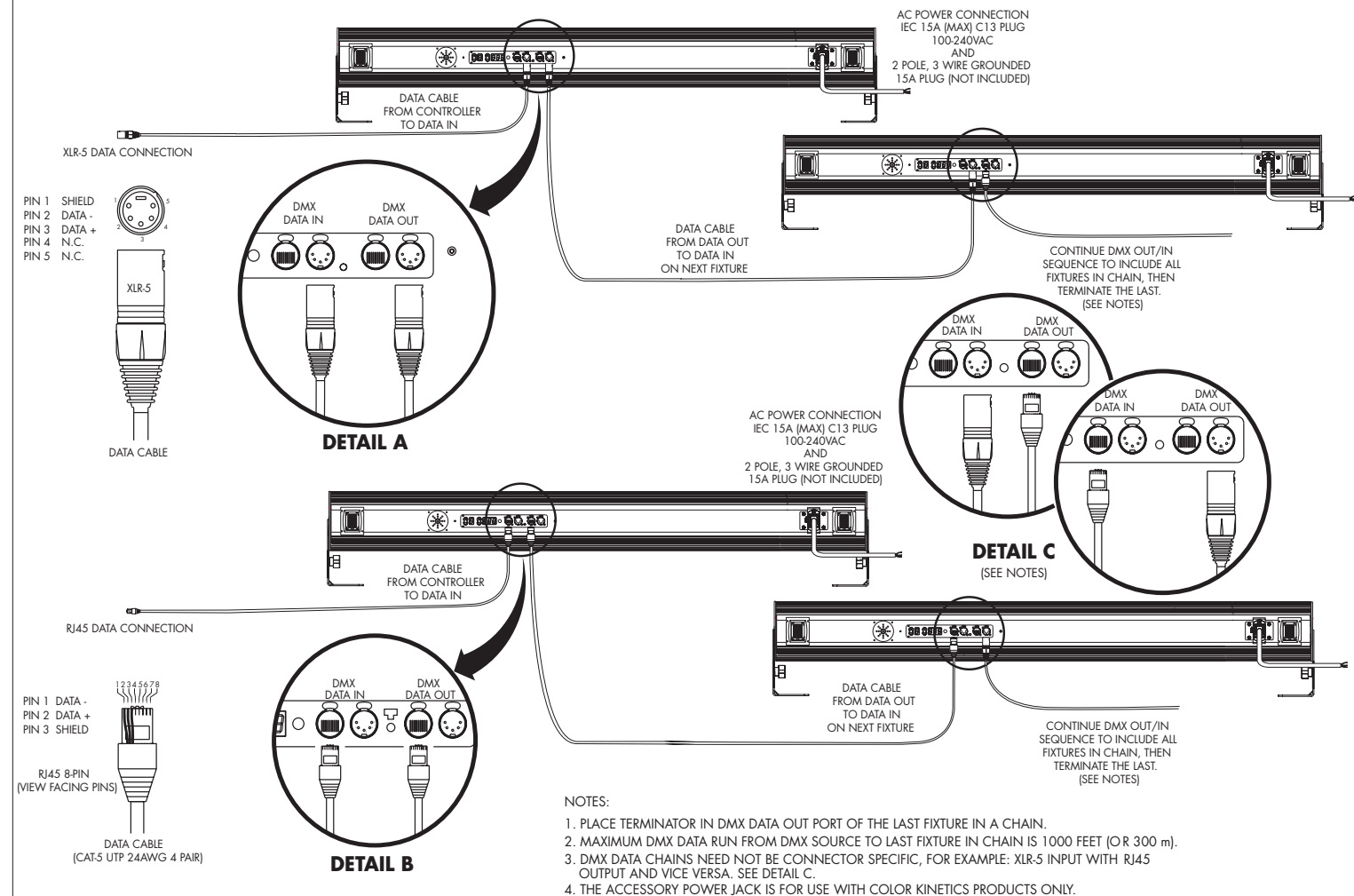

IMPORTANT INFORMATION

Strobe Warning

There is some anecdotal evidence that strobe lighting may induce epileptic symptoms in certain susceptible individuals, although no associated product warnings have been issued by United States government according to the Food and Drug Administration.

If strobe lights are used, some international regulatory agencies¹ recommend keeping flicker rates at or below four flashes per second (as less of the flicker-sensitive population will then be at risk of an attack). This flicker rate applies only to the overall output of any group of lights in direct view. However, when more than one strobe light is used, the flashes should be synchronized. End users should also consider issuing a warning, alerting audience or viewers to the presence of strobe lighting.

Temperature Monitoring

For protection from extreme temperatures, ColorBlaze has been designed with a temperature monitoring feature. If operating temperatures rise to an unsafe level, a compensation circuit is triggered and the operation of some or all light segments is interrupted causing the lights to turn dull red. After 30 minutes the lights will auto-cycle and return to full intensity.

To prevent additional power shut-downs, determine the cause of the overheating and correct the problem.

Fan Control

For additional heat protection, ColorBlaze is equipped with a fan control. At elevated ambient temperatures the fan engages at 1/2 RPM. If ambient temperature continues to increase, the fan will go to full speed to protect the circuitry and ensure long life of the fixture.

If any problems occur during usage, unplug the product immediately and call or email Color Kinetics Technical Support Group at: 1-888-FULL RGB or 617-423-9999 or support@colorkinetics.com.

COLORBLAZE SPECIFICATIONS

COLOR RANGE	16.7 million (24 bit) additive RGB colors Continuously variable intensity output range
SOURCE	High intensity power LEDs
BEAM ANGLE	10°
HOUSING	Extruded Aluminum with black or white finish
POWER CONNECTORS	IEC 15A (max) with C13 plug 2-pole, 3-wire, grounded, 15A (not included)
DATA CONNECTORS	RJ45 or XLR-5
LISTINGS	UL/cUL, CE, PSE
DATA INTERFACE	DMX512
CONTROL	Color Kinetics full line of DMX controllers or other DMX512 controllers
POWER REQUIREMENT	100-240VAC
POWER CONSUMPTION	ColorBlaze 48: 280W, 2.5A nominal at full intensity (full RGB) ColorBlaze 72: 420W, 3.7A nominal at full intensity (full RGB)
TEMPERATURE RANGE	-40°F to 122°F (-40°C to 50°C) operating temperature 14°F to 122°F (-10°C to 50°C) starting temperature

LED SOURCE LIFE

In traditional lamp sources, lifetime is defined as the point at which 50% of the lamps fail. This is also termed Mean Time Between Failure [MTBF]. LEDs are semiconductor devices and have a much longer MTBF than conventional sources. However, MTBF is not the only consideration in determining useful life. Color Kinetics uses the concept of useful light output for rating source lifetimes. Like traditional sources, LED output degrades over time (lumen depreciation) and this is the metric for SSL lifetime.

LED lumen depreciation is affected by numerous environmental conditions such as ambient temperature, humidity, and ventilation. Lumen depreciation is also affected by means of control, thermal management, current levels, and a host of other electrical design considerations. Color Kinetics systems are expertly engineered to optimize LED life when used under normal operating conditions. Lumen depreciation information is based on LED manufacturers' source life data as well as other third party testing. Low temperatures and controlled effects have a beneficial effect on lumen depreciation. Overall system lifetime could vary substantially based on usage and the environment in which the system is installed.

Temperature and effects will affect lifetime. Color Kinetics rates product lifetime using lumen depreciation to 50% of original light output. When the fixture is running at room temperature using a color wash effect, the range of lifetime is in the range of 80,000-100,000 hours. This is LED manufacturers' test data. High output is defined as any LED device that is 1/2 watt or above. For more detailed information on source life, please see www.colorkinetics.com/lifetime.

WARRANTY

This product is sold pursuant to CK's Standard Terms and Conditions (the "T&Cs") which may be found at <http://colorkinetics.com/howtobuy/buy/terms> and which contain important provisions, including, among others, Limited Warranty, exclusions and limitations on CK's liability for damages, and restrictions on the remedies that are available to you.

¹ Guide to Health, Safety and Welfare at Pop Concerts and Similar Events, HMSO Publications (UK)